

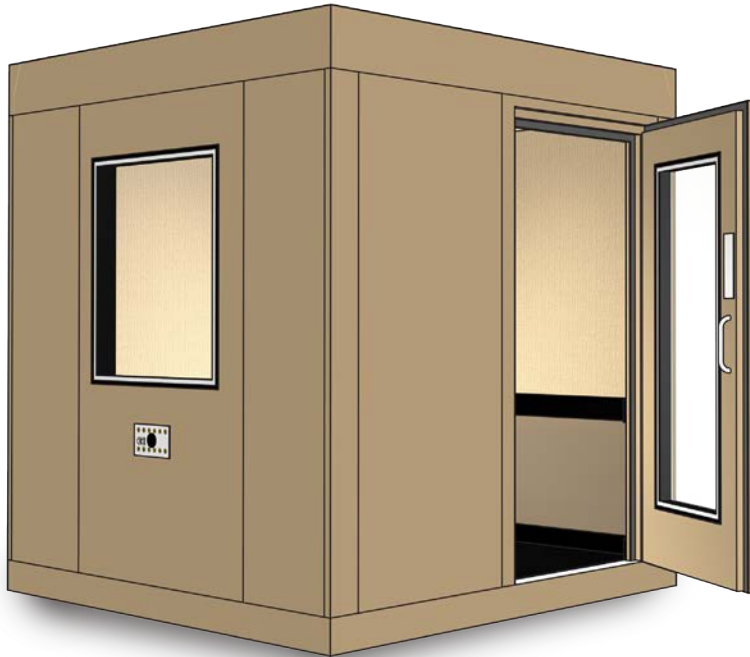

# Data Sheet

## 40a Classic Series Audiometric Booth



The **40a Classic Series Single-Wall** (individual room) construction is a single or multiple occupancy room constructed of 4" thick modular panels, complete with carpeted vibration isolated floor, space-saver roof mounted ventilation, recessed electrical, Noise-Lock® doors and double glazed windows, audiometric jack panels acoustically matched and shipped ready for field assembly.

- NIC 50
- NIC 53 with 1" Enhancement Package

**Typical Plan**

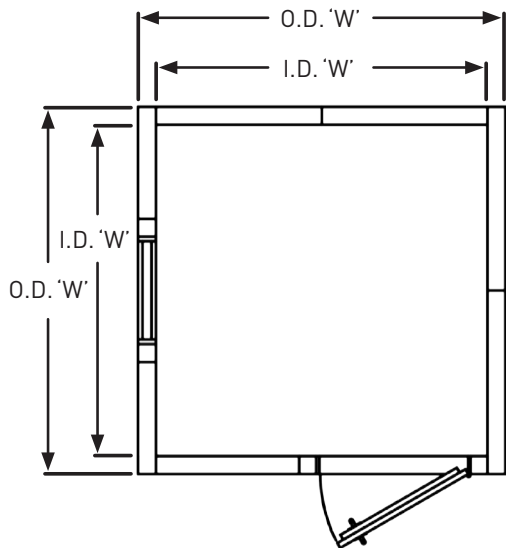

Model No.	Inside Dimension ft-in x ft-in x ft-in					Outside Dimension ft-in x ft-in x ft-in					Weight (lbs)
	L	x	W	x	D	L	x	W	x	H	
40a-1	2-10	x	3-6	x	6-6	3-6	x	4-2	x	7-7	1131
40a-2	3-6	x	4-4	x	6-6	4-2	x	5-0	x	7-7	1477
40a-2.5	3-6	x	6-2	x	6-6	4-2	x	6-10	x	7-7	1868
40a-3	3-6	x	6-8	x	6-6	4-2	x	7-4	x	7-7	1982
40a-4	4-8	x	7-0	x	6-6	5-4	x	7-8	x	7-7	2473
40a-5	6-2	x	6-2	x	6-6	6-10	x	6-10	x	7-7	2670
40a-5.5	6-4	x	7-6	x	6-6	7-0	x	8-2	x	7-7	3113
40a-6	7-0	x	7-0	x	6-6	7-8	x	7-8	x	7-7	3149
40a-7	7-0	x	7-6	x	6-6	7-8	x	8-2	x	7-7	3316
40a-7.5	6-4	x	8-4	x	6-6	7-0	x	9-0	x	7-7	3345
40a-8	7-0	x	8-8	x	6-6	7-8	x	9-4	x	7-7	3668
40a-9	7-0	x	9-10	x	6-6	7-8	x	10-6	x	7-7	4008
40a-10	8-2	x	8-8	x	6-6	8-10	x	9-4	x	7-7	4061
40a-11	8-6	x	8-6	x	6-6	9-2	x	9-2	x	7-7	4113
40a-12	8-2	x	9-10	x	6-6	8-10	x	10-6	x	7-7	4429
40a-13	9-4	x	9-10	x	6-6	10-0	x	10-6	x	7-7	4896
40a-13.5	8-8	x	11-2	x	6-6	9-4	x	11-10	x	7-7	5053
40a-14	10-6	x	9-10	x	6-6	11-2	x	10-6	x	7-7	5310





# Data Sheet

## 40a Classic Series Audiometric Booth



### Total Estimated Design Weight:

See table on page 1

### Panel Construction:

Noise-Lock® V (walls) and Noise-Lock® VI (ceiling)

### Panel Size:

Maximum panel size to be determined by customer for adequate site access.

### Interior Surfaces:

22ga. galvanized perforated steel

### Exterior Surfaces:

14ga. cold rolled solid steel

### Floor Interior Surface:

11ga. hot rolled steel

### Finish:

Textured powder coated

### Door:

(1) 2'-9" wide x 6'-1½" high clear opening cam-lift splitframe with push plate and pull handles

### Note:

- Dimensions locating door are shown to the clear opening
- Noise-Lock® STC-51

### Window:

(1) 2'-6" wide x 2'-10" high aluminum frame double glazed with ¼" thick laminated safety glass (width reduced on smaller models)

### Booth Vibration Isolation:

Vibration isolator rails to be provided below floor panels

### Electrical:

- 120V recessed incandescent light fixture
- 120V toggle switch for fans and lights
- 120V duplex receptacle

### Note:

- Customer to provide 110V, 60Hz, 20 amp power to roof mounted quad receptacle power cord
- All electrical is wired per 2002 national electric code
- Booth is factory UL certified and labeled
- (Lot) boxes, connectors, etc. as required for complete installation

### Audiometric Jack Panel Comprised of:

- (12) Switchcraft three-wire phone-type jacks
- (2) USB ports
- (1) 2" ID passthrough hole with cover

### Booth Options:

#### Ventilation:

Integrated SpaceSaver exhaust/inlet air ceiling silencer panels and 120V, 60Hz, 14w fans or HVAC connection collars to connect to building system

#### Available Colors:

- Khaki Shade
- Kinetic Khaki
- Polar Blue
- Colony Blue
- Limoge Cream
- Cinnamon Stick
- Celedon
- Jade Market
- First Star
- Silver Plate
- Pure White
- Gray Primer

#### Floor Covering:

Nylon carpet, to match paint color selection with 3/8" thick underlayment and 2-1/2" H black cove base molding included

#### Site Requirements:

- Customer to provide a finished floor which is within +/- ¼" of level in 10 non-cumulative feet
- 2" minimum clearance is required between the exterior of testing booth and host facility walls/ceiling



**IAC Acoustics**

North Aurora, Illinois

T: 630 270 1790

F: 630 966 9710

E: [iacacoustics@soundseal.com](mailto:iacacoustics@soundseal.com)

[www.iacacoustics.com](http://www.iacacoustics.com)

Ref#: 40a-170315-01



# Accutone2 Series Audiometric Room Options



## Doors:

- Noise-Lock® double-glazed windows in door
  - 12" x 12" View Port
  - 16" x 24" Side Light
  - 20" x 60" Full Glass
- Additional & oversized doors including double leaf
- Wood veneered door finishes
- Mortised type, lever handle, recessed key locks
- Door closers



## Optional Equipment:

- One-way Noise-Lock® glass
- One-way Noise-Lock® glass on sliding rails
- RF & electromagnetic shielding
- Special jack-panels
- Pass throughs
- Fire rated outer walls and doors

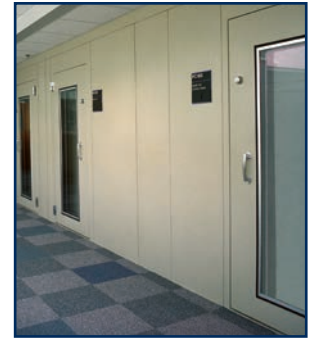

## Standard Enhancement Packages:

- Enhancement packages available with choice of fabric & liner colors
- Paneling & carpeting in 5 colors
- Absorptive & aesthetic fabric top paneling
- Space-enhancing chair-rail
- Edge-smoothing corner panels

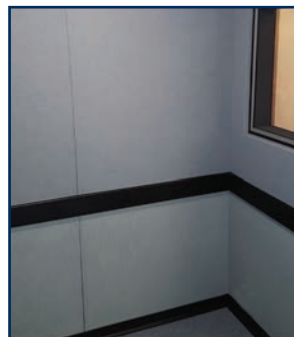
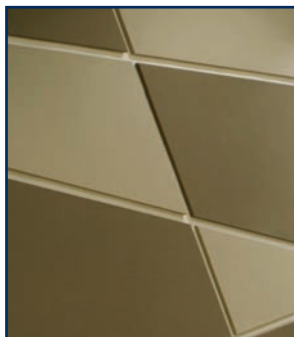

## Exterior Enhancement Packages:

- Exterior enhancement packages available with WoodTrends by Sound Seal
- Aesthetically pleasing finishes that show off the beauty of real wood
- Available in a variety of popular as well as exotic wood veneer species (additional veneer options available upon request)

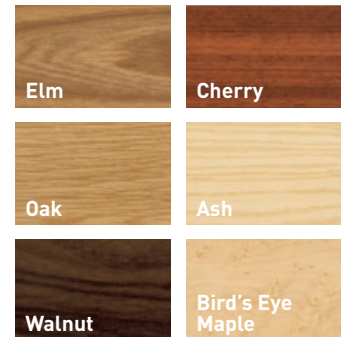



# Data Sheet

## 40a Classic Series Audiometric Booth



# AccuTone<sup>2</sup> Enhanced Performance Audiometric Series

**Room Noise Reduction**

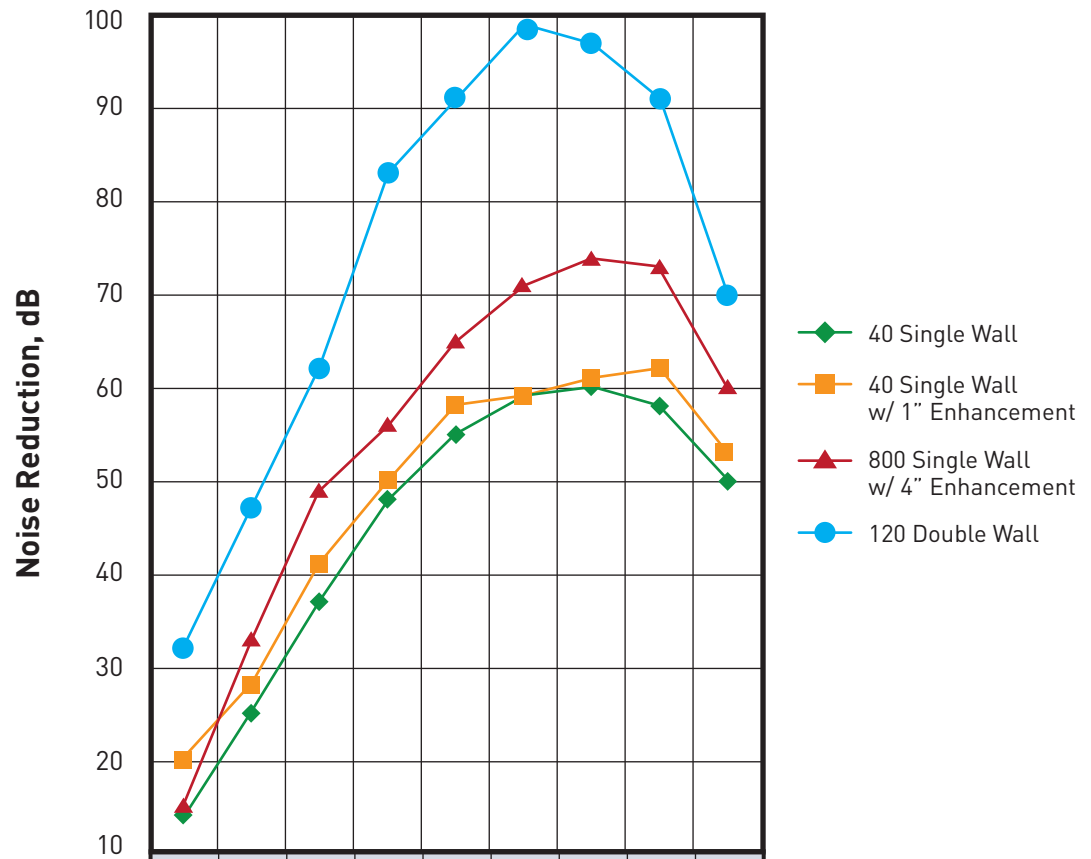

	63	125	250	500	1K	2K	4K	8K	NIC
◆ 40 Single Wall	14	25	37	48	55	59	60	58	50
■ 40 Single Wall w/ 1" Enhancement	20	28	41	50	58	59	61	62	53
▲ 800 Single Wall w/ 4" Enhancement	15	33	49	56	65	71	74	73	60
● 120 Double Wall	32	47	62	83	91	99	97	91	70

**Octave Band Center Frequency, Hz**



**IAC Acoustics**

North Aurora, Illinois

T: 630 270 1790

F: 630 966 9710

E: [iacacoustics@soundseal.com](mailto:iacacoustics@soundseal.com)

[www.iacacoustics.com](http://www.iacacoustics.com)

Ref#: 40a-170315-01